

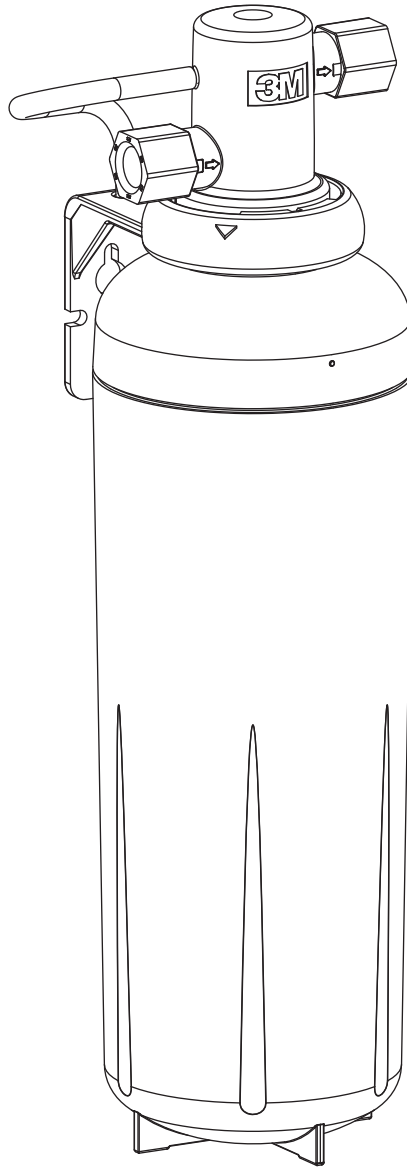

3M Clean Water Solutions

Installation and Operating Instructions For 3MDW301 Advanced Drinking Water System





Homeowner: Please retain for operation and future maintenance instructions.

SAFETY INFORMATION

Please read and follow all safety information contained in these instructions prior to installation and use of the 3MDW301 Advanced Drinking Water System. Retain these instructions for future reference.

Intended use:

The 3MDW301 Advanced Drinking Water System is intended for use in filtering potable water in homes and has not been evaluated for other uses. The system is installed at the point of use and typically installed under a sink. System must be installed as specified in the installation instructions by a qualified professional.

EXPLANATION OF SIGNAL WORD CONSEQUENCES	
 WARNING	Indicates a potentially hazardous situation, which, if not avoided, could result in death or serious injury and/or property damage.
 CAUTION	Indicates a potentially hazardous situation, which, if not avoided, may result in minor or moderate injury and/or property damage.
CAUTION	Indicates a potentially hazardous situation, which, if not avoided, may result in property damage.

 WARNING
<p>To reduce the risk associated with choking:</p> <ul style="list-style-type: none"> • Do not allow children under 3 years of age to have access to small parts during the installation of this product.
<p>To reduce the risk associated with ingestion of contaminants:</p> <ul style="list-style-type: none"> • Do not use with water that is microbiologically unsafe or of unknown quality without adequate disinfection before or after the system. Systems certified for cyst reduction may be used on disinfected water that may contain filterable cysts. EPA Establishment #070595-CT-001.
<p>To reduce the risk associated with a hazardous voltage due to an installer drilling through existing electric wiring or water pipes in the area of installation:</p> <ul style="list-style-type: none"> • Do not install near electric wiring or piping which may be in the path of a drilling tool when selecting the position to mount the filter bracket.

 CAUTION
<p>To reduce the risk of eye injury while drilling countertop for faucet installations:</p> <ul style="list-style-type: none"> • Safety glasses MUST be worn during the sink hole drilling operations.

CAUTION
<p>To reduce the risk associated with property damage due to water leakage:</p> <ul style="list-style-type: none"> • Read and follow Use Instructions before installation and use of this system. • Installation and use MUST comply with all state and local plumbing codes. • Protect filter from freezing, remove replacement filter when temperatures are expected to drop below 40°F (4.4°C). • Do not install systems in areas where ambient temperatures may go above 110°F (43.3°C). • Do not install on hot water supply lines. The maximum operating water temperature of this filter system is 100°F (37.8°C). • Do not install if water pressure exceeds 125 psi (862 kPa). If your water pressure exceeds 80 psi (552 kPa), you must install a pressure limiting valve. Contact a plumbing professional if you are uncertain how to check your water pressure. • Do not install where water hammer conditions may occur. If water hammer conditions exist you must install a water hammer arrester. Contact a plumbing professional if you are uncertain how to check for this condition. • Where a backflow prevention device is installed on a water system, a device for controlling pressure due to thermal expansion must be installed. • Do not use a torch or other high temperature sources near filter system, cartridges, plastic fittings or plastic plumbing. • On plastic fittings, never use pipe sealant or pipe dope. Use PTFE thread tape only, pipe dope properties may deteriorate plastic. • Do not install in direct sunlight or outdoors. • Do not install near water pipes which will be in path of a drilling tool when selecting the position to mount the bracket; • Mount filter in such a position as to prevent it from being struck by other items used in the area of installation (waste baskets, etc.); • Ensure that the location and fasteners will support the weight of the system when installed and full of water. • Ensure all tubing and fittings are secure and free of leaks. • Do not install unit if collet is missing. Contact 3M if collets are missing from any fittings. • The disposable replacement filter MUST be replaced every 12 months, at the rated capacity or sooner if a noticeable reduction in flow rate occurs.

IMPORTANT NOTES
<ul style="list-style-type: none"> • Failure to follow instructions will void warranty. • Allow a minimum of 3" (7.6 cm) clear space under filter to facilitate filter change. • Install with the inlet and outlet ports as labeled. Make sure not to reverse connections.

GETTING STARTED



- Installation requires some household tools and novice plumbing skills. If you replace your own kitchen and bathroom faucets, you can handle this!
- Installation may require drilling a hole in your sink top. A variable speed drill and specialized drill bits may be needed. We highly recommend professional installation!

Parts and Materials Included:

- Replacement Filter
- Filter Head Assembly
- (4) 3/8" NPT x 1/4" Quick Connect Fittings
- (1) 3/8" IPS x 1/4" Feedwater Adapter
- (2) Phillips Head Mounting Screws
- (2) Mounting Screw Star Washers
- (1) Quick Connect 1/4" Ball Valve
- 7' of 1/4" Plastic Tubing
- Faucet Adapter 3/8" x 1/4" Quick Connect Fitting
- Performance Indicator Device (PID) including batteries

Items Required (not included):

- Adjustable wrench
- Cordless drill
- Phillips head screwdriver
- Razor knife
- PTFE tape
- Drinking water faucet - Standard and designer faucet options are available at www.3MCleanerWorld.com

1 Replacement Filter 2 Filter Head Assembly

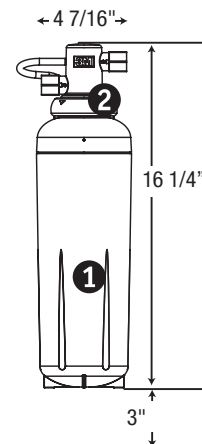

Typical Installation Example

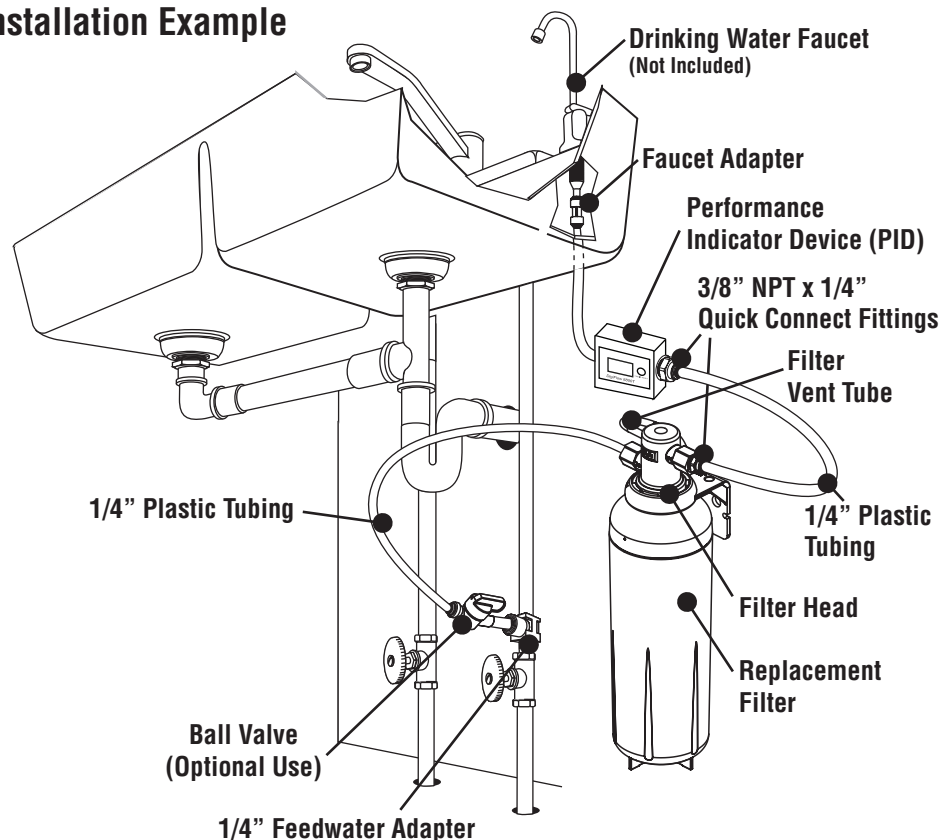

DRINKING WATER FAUCET INSTALLATION

The following instructions assume you purchased an accessory 3M™ Drinking Water Faucet or 3M™ Designer Drinking Water Faucet with your Drinking Water System.

⚠ CAUTION

To reduce the risk of eye injury while drilling countertop for faucet installations:

- Safety glasses **MUST** be worn during the sink hole drilling operations.

IMPORTANT NOTES

- The drinking water system faucet should be located on a flat surface, conveniently located near the sink, so that it empties into the sink. Most sinks have pre-drilled holes designated for sprayers, soap dispensers, and other accessories. If your sink does not have an extra hole, **we highly recommend professional installation.**
- Porcelain, enamel, and ceramic sinks require special procedures for drilling holes. **Professional installation is highly recommended. (See page 7)**

Drilling 9/16" diameter hole through countertop or stainless steel sink:

1. Locate area to be drilled. Mark center of hole with center punch.
2. Drill hole with 9/16" drill bit suitable for countertop materials or cast iron/stainless steel.
3. With grinding wheel or file, smooth out any rough edges.

Installing the faucet:

1. Slide the following parts in the order specified up blue tubing and threaded stem:
 - a. Metal bezel
 - b. Large rubber washer
2. Next, feed blue tubing and faucet stem down through faucet mounting hole.
3. From underneath sink, assemble the black spacer, star washer, and hex nut (as shown) onto the threaded stem and tighten by hand.
4. With a padded adjustable wrench, turn the faucet base (above the counter) to the right to securely fasten. Raise faucet handle and remove plastic shipping tube from base.
5. Insert faucet neck onto base until seated and align over sink. Lower faucet handle.

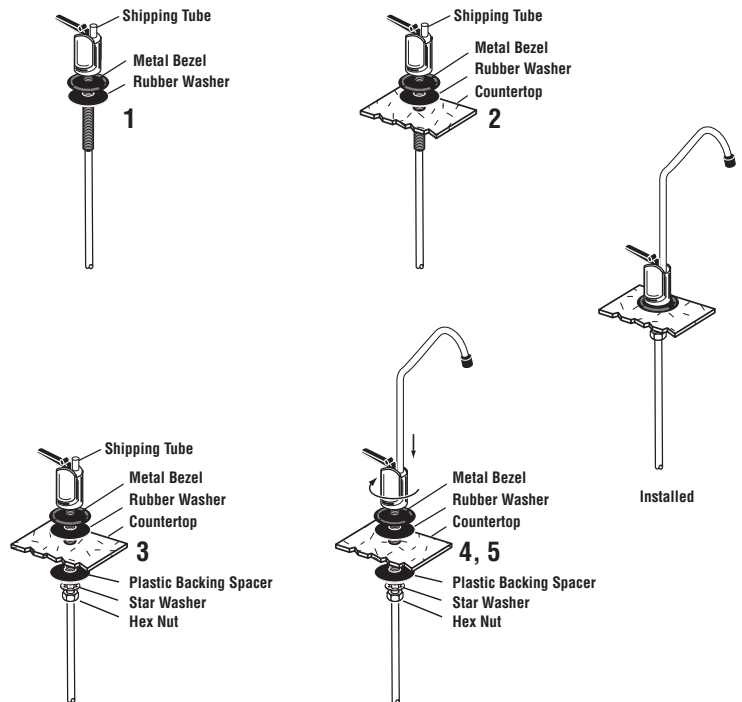

Figure 1

IMPORTANT INSTALLATION INSTRUCTIONS

For Use With Cold Water Only.

NOTE: Remove items from under the sink. Place catch basin there to collect small amounts of water that may run out when disconnecting water supply lines.

1. Open faucet and turn off cold water supply to relieve pressure.
Install (2) quick connect fittings into head assembly using PTFE thread tape only.
2. Place a basin or a towel under the cold water supply valve. Remove cold side riser tubing connection at cold water supply valve. Install feedwater adapter to the cold water supply valve and reconnect the riser tubing.
3. Select and mark a location under the sink that allows access for filter change.
4. Using filter head assembly as a guide, mark hole locations so that there is 1 1/2" between the screws (see Figure 2), from center of each screw.

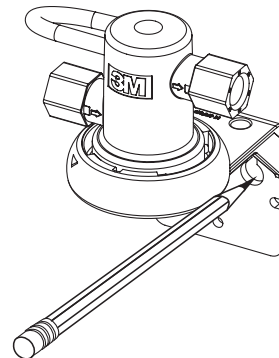

Figure 2

Install screws and washers halfway, so you can easily slip the bracket to wall before firmly setting screws. **NOTE:** If you are mounting onto sheetrock or drywall, use anchors or screws (not included).

When installed, the bottom of the filter should have a minimum clearance of 3" from sink cabinet floor to facilitate replacement filter change.

Fasten filter head assembly to wall with Phillips head mounting screws supplied.



Correct



Incorrect

5. Cut tubing straight with a razor knife.
(See Figure 3).

Figure 3

Determine length of tubing required from filter head assembly to feedwater adapter and from the filter head assembly to the mounted Performance Indicator Device (PID) by holding tubing in place ensuring it is of appropriate length. Do not kink tubing as this will impede water flow. If necessary, loop tubing around to avoid it being kinked. (Refer to typical installation example found on Page 3). Install and mount PID per PID mounting instructions on page 6, ensuring that the tubing from the bottom of the faucet can reach the outlet fitting of the PID.

Connect 1/4" tubing from feedwater adapter to inlet side of filter head. (See "Using Push-In Fittings")

You may choose to install the optional Quick Connect 1/4" Ball Valve (included) in the line between the feedwater adapter and the filter assembly.

"Using Push-In Fittings"

To Attach Tubing

- (1) Push tubing in as far as it will go.
- (2) Tubing must be inserted past o-ring and hit backstop. Pull tube to ensure it is secured.

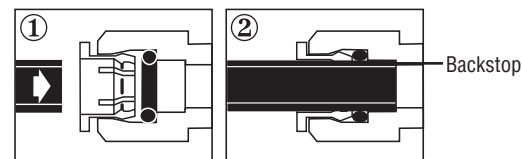

To Release Tubing

- (3) Push in collet to release tubing.
- (4) With collet held, pull tubing straight out.

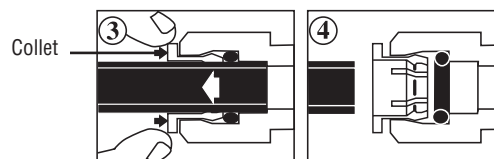

CAUTION

- To reduce the risk associated with property damage due to water leakage:
- Ensure all tubing and fittings are secure and free of leaks.

IMPORTANT INSTALLATION INSTRUCTIONS (CONTINUED)

6. Referring to the “Using Push-In Fittings” section on the previous page, insert one end of tubing into outlet side of filter head assembly as indicated by arrow on filter head assembly. (see Figure 4) Insert the remaining end of tubing into the PID.
7. The following instructions assume you purchased an accessory 3M™ Drinking Water Faucet or 3M Designer Drinking Water Faucet with your Drinking Water System. If you purchased an after market faucet, these instructions may not apply. Refer to instructions provided with faucet or call 3M Customer Care Representatives at 1-877-238-9119 for assistance with the installation. Insert tubing from faucet into outlet side of PID.
8. Remove sanitary protective cap from new filter. Ensure both o-rings are present on the filter and are seated into grooves; moisten o-rings with water. DO NOT use any petroleum products to lubricate the o-rings.
9. Insert filter into filter head assembly. Turn filter one quarter turn to the right (clockwise) until it stops. When fully engaged, the top surface of the filter will be flush with the bottom of the filter head assembly.
10. Turn on water and open filter system faucet to flush air from the system. Run water for a minimum of 4 gallons (approximately 5 minutes) to flush system. While system is flushing, check for leaks. Repair any leaks as needed before continuing.

Close filter system faucet. The system is now ready for use. System is now under pressure and can be inspected for leaks. Repair any leaks as needed before continuing.

Note: White tube from head is a filter vent tube outlet. DO NOT remove, kink or obstruct white tube.

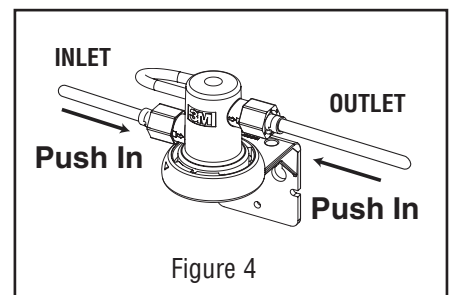

OPERATION INSTRUCTIONS FOR THE PERFORMANCE INDICATOR DEVICE (PID)

1. Install batteries (included): Remove the battery compartment cover located on the top of the unit and install two (2) “AAA” batteries. Replace battery compartment cover. The LCD panel should now show “1,000 gal”.
2. Install (2) quick connect fittings into PID using PTFE thread tape only. Install both fittings to a distance of 1/8” (0.32 cm) from flow monitor housing (see Figure 6 to the right).
3. Operation: The PID turns on and shows remaining capacity on the screen when there is water flowing through it. The display on the LCD screen turns off in 10 seconds if there is no water flowing. To check the status of the remaining capacity of the installed filter, press the “CHECK/RESET” button.
4. End of Filter Life Alarm: When the remaining capacity of the installed filter reaches 0 gallons as indicated on the LCD screen, the PID will sound a short “beep-beep” alarm and the “0” digit on the LCD screen blinks, signaling time to replace the filter.
5. Reset PID: After the filter has been replaced, press the “CHECK/RESET” button for four (4) seconds. A long “beep” sound can be heard and the remaining capacity on the LCD screen is reset to 1,000 gallons.
6. Low Battery Power Alert: When the battery power is low and there is water flowing through the PID, a “beep-beep” sound can be heard and the empty battery symbol on the LCD screen will blink to notify the user to change the batteries. The PID will hold memory of total water flow recording while changing batteries.

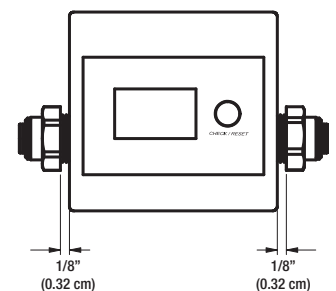
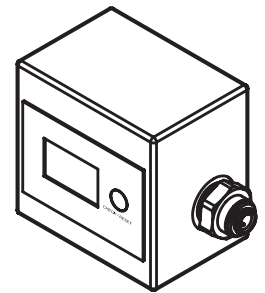

DRILLING HOLE THROUGH PORCELAIN/ENAMEL/CERAMIC SINKS

IF YOU ARE READING THIS SECTION, PROFESSIONAL INSTALLATION IS HIGHLY RECOMMENDED.

⚠ CAUTION

To reduce the risk of eye injury while drilling countertop for faucet installations:

- Safety glasses **MUST** be worn during the sink hole drilling operations.

Drilling Hole through Porcelain/Enamel/Ceramic Sinks

Recommended Tools:

- Variable Speed Drill
- Porcelain Cutter Tool Set (9/16" Size)
- Plumber's Putty

Note: It is important to understand this procedure.

1. The glassy layer of porcelain/enamel/ceramic must be scored through to the metal base, creating a disk.
2. This disk must be removed while protecting the surrounding decorative coating against chipping or fracturing.
3. The base metal must be drilled through to complete the hole.

Procedure:

1. Mark center for 9/16" hole.
2. Form a dam of shallow putty around hole location and fill with enough water to lubricate carbide drill bit.
3. Carefully drill pilot hole through porcelain/enamel/ceramic and base metal using a carbide pilot drill. Always operate drill with light pressure at slow speed (300 - 400 rpm).
4. Drill porcelain/enamel/ceramic using special 9/16" cutting tool, making certain a complete ring has been cut through to the sink's metal base.
5. Change to metal cutting drill bit and drill out the center of the ring, making sure not to contact other rim of decorative coating. Cut through metal sink base.

FILTER REPLACEMENT INSTRUCTIONS

CAUTION

To reduce the risk associated with property damage due to water leakage:

- The disposable filter cartridge **MUST** be replaced every 12 months, at the rated capacity or sooner if there is a noticeable reduction in flow rate, whichever occurs first.

1. Place towel under filter to collect any residual water during filter change-out.
2. Grasp filter and turn to the left (counterclockwise) until filter comes to a complete stop (water automatically turns off). Water may leak momentarily from vent tube. This is normal. Gently pull filter downward to remove.
3. Remove sanitary protective cap from new replacement filter.
4. Ensure both o-rings are present on the replacement filter and are seated into grooves; moisten o-rings with water. DO NOT use any petroleum products to lubricate the o-rings.
5. Insert replacement filter into filter head assembly. Turn replacement filter one quarter turn to the right (clockwise) until it stops. When fully engaged, the top surface of the filter will be flush with the bottom of the filter head assembly. (See Figure 7)
6. Reset PID: After the filter has been replaced, press the "CHECK/RESET" button for four (4) seconds. A long "beep" sound can be heard and the remaining capacity on the LCD screen is reset to 1,000 gallons.
7. Open faucet and run water for a minimum of 4 gallons (approximately 5 minutes). While system is flushing, check for leaks. Repair any leaks as needed before continuing.

Close filter system faucet. System is now under pressure and can be inspected for leaks. Repair any leaks as needed before continuing. The system is now ready for use.

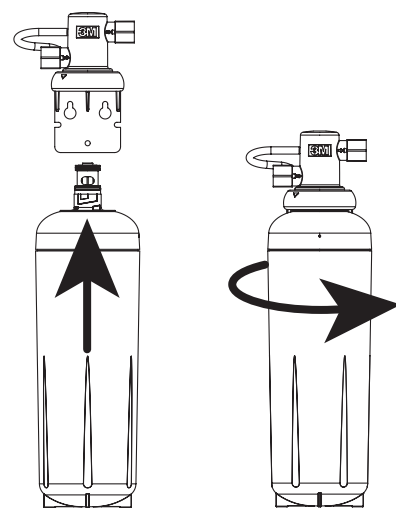

Figure 7

TROUBLESHOOTING GUIDE

Water Leaks at Push-In Connections:

Push tubing in as far as it will go. If leaking continues, shut off water at the cold water supply valve and remove water line by pushing in on the connector collet while pulling the tubing away. Inspect tubing for cracks and scratches. If tubing is cracked or scratched, simply cut that portion away and reinsert tubing into push-in fitting.

Make sure tubing is cut squarely. If not, recut correctly. Please refer to Figure 3.

If water leaks, please verify that the o-rings are properly seated in their grooves.

Water Does Not Flow From The Drinking Water System Faucet:

Check to see if the main water line valve is open, allowing water to flow to the filter. Make sure the connections are not reversed.

Water Appears Cloudy or Air Comes Out of the Drinking Water System Faucet:

Flush filter for a minimum of 4 gallons (approximately 5 minutes).

LIMITED WARRANTY

Limited Warranty: 3M Purification Inc. warrants this Product will be free from defects in material and manufacture for the following periods from the date of purchase: Five (5) years for the Product, except for the replacement filter cartridge and membrane, which are warranted for one (1) year. This warranty does not cover failures resulting from abuse, misuse, alteration or damage not caused by 3M or failure to follow installation and use instructions. No warranty is given as to the service life of any filter cartridge or membrane as it will vary with local water conditions and water consumption. If the Product fails to satisfy this Limited Warranty during the warranty period, 3M will replace the Product or refund your Product purchase price. This warranty does not cover labor. The remedy stated in this paragraph is Customer's sole remedy and 3M's exclusive obligation.

This warranty gives you specific legal rights, and you may have other rights which may vary from state to state, or country to country. For any warranty questions, please call 1-877-238-9119 or mail your request to: Warranty Claims, 3M Purification Inc., 400 Research Parkway, Meriden, CT 06450. Proof of purchase (original sales receipt) must accompany the warranty claim, along with a complete description of the Product, model number and alleged defect.

Limitation of Liability: 3M will not be liable for any loss or damage arising from this 3M product, whether direct, indirect, special, incidental, or consequential, regardless of the legal theory asserted, including warranty, contract, negligence or strict liability. Some states and countries do not allow the exclusion of limitation of incidental or consequential damages, so the above limitation or exclusion may not apply to you.

3M is a trademark of 3M Company.

© 2009 3M Company. All rights reserved.

INSTR8027 0909



Manufactured by 3M
400 Research Parkway
Meriden, CT 06450
1-877-238-9119
www.3MCleanerWorld.com